

Corrosiveness to Copper from Petroleum Products

ASTM D130 - EN/ISO 2160 - IP 154 - DIN 51811 - ASTM D4048 - IP 112 - ASTM D7095



Item	Unit	TC16
P/N		31T0671
230V/50-60Hz		
P/N		31T0861
115V/60Hz		
Power	[kW]	1.5
Range	°C °F	Ambient .. 250 Ambient ..482
Reading		°C or °F
Setting	[°]	0.1
Stability	[°C]	0.02
Heating	[kW]	1.4
Bath volume	[L]	16
Bath opening	[mm]	6 x ø51 mm (9 x ø51 optional)
Bath depth	[mm]	220
Length	[mm]	480
Width	[mm]	295
Height	[mm]	480
Materials		Used inside bath: stainless steel 304, brass
CE		Conforms to CE regulation

- ⊕ **Stainless steel bath**
- ⊕ **Cooling coil**
- ⊕ **Bath drain**
- ⊕ **Easy to operate**
- ⊕ **Position for 6 test cylinders (9 optional)**

General

The test method covers the detection of the corrosiveness to copper of aviation gasoline, aviation turbine fuel, automotive gasoline, natural gasoline or other hydrocarbons having a Reid Vapour Pressure no greater than 18 psi. The cover of the bath has six openings, each with a lid and hook for suspending a copper corrosion test vessel (P/N 14T0100). Or the openings can accommodate test tubes in holders (P/N 14T0102). The temperature range is from ambient +5°C to 250°C. Optional is a cover with nine openings to test nine samples (P/N 03T2311).

Accuracy

The construction of the bath and electronic design result in a very stable working temperature of $\pm 0.02^\circ$. The set point can be set in steps of 0.1° in the range of 0°C up to 250°C ($-148..482^\circ\text{F}$). The accuracy on the display is displayed in 0.1°C . However the controller has an internal accuracy of 0.01°C .

Temperature readout

Standard available in $^\circ\text{C}$, on request in $^\circ\text{F}$.

Pump

When not used for copper corrosion tests, the pump can be used to circulate the bath content to an external application.

Safety

The bath conforms to CE regulation. It is further equipped with a mechanical resettable safety thermostat. Optional is a level protection device to warn the user when the level of the bath fluid is too low (P/N 07T0080).



Baths with more positions

We also offer a TC40 bath with a cover for 18 positions (P/N 03T2313). Alternatively, we can supply the TC40 with a cover and levelling platform for 63 glass test tubes (P/N 09T0010) when testing non volatile samples. Please see table 6 for more information.

Corrosiveness to Copper from Petroleum Products

Accessories

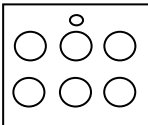

Table 1: Apparatus P/N 31T0671 or P/N 31T0861 standard consists of:			
P/N	Picture	Quantity	Description
00T0671		1	TC16 circulator bath, 230V/50-60Hz
00T0861			TC16 circulator bath, 115V/60Hz
13T8000		1	Top lid with six ø51 mm openings and a thermometer opening
14T0101		6	Lid and mounting hook









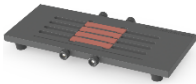





Table 2: Optional for ASTM D130			
P/N	Picture	Suggested quantity	Description
03T2311		1	Top lid with nine ø51 mm openings. Please separately order 3 * P/N 14T0101 additionally.
14T0101		3	Lid and mounting hook for P/N 03T2311
07T0080		1	Float/level detector

Table 3: Accessories for corrosion tests		
P/N	Picture	Description
14T0100		Pressure vessel for copper strip corrosion test (test cylinder with o-ring). Cylinder is supplied with works certificate for overpressure and leakage tests.
31T0003		ASTM copper strip corrosion test standard.
31T0002		Copper strip (per one strip) 12.5 x 3.0 x 75 mm (width x thick x length) 99.9 % purity.







Corrosiveness to copper from Petroleum Products

Accessories

Table 3: Accessories for corrosion tests		
P/N	Picture	Description
31T0001.100		Sanding paper silicon carbide P220 (box of 100 pieces)
09T0010		Test tube 25 x 150mm
14T0102		Test tube (25 x 150 mm) holder
31T0000		Multistrip vise, holds up to four strips while polishing
31T0005		Silicon carbide powder 105 µm (1 kg)
09T0011		Flat viewing test tube
08T0001		Bath fluid silicon oil 20..150°C 20ltr
25T0928BW		ASTM thermometer similar to 34C with blue filling (low-hazardous to ship). Temp. range +25°C-105°C:0.2°C. Supplied with works certificate.
25T2154		Thermometer holder, 425 x 10mm
31T0008		Vented stopper made from silicon rubber for test tube (P/N 09T0010). 25 pieces. Width 24 (top) to 18 (bottom) mm. Length 30 mm. Hole of 4 mm. Temperature resistant from -60 to +180°C.

Corrosiveness to copper from Petroleum Products

Accessories

Table 3: Accessories for corrosion tests		
P/N	Picture	Description
31T0009.100		Sanding paper silicon carbide P240 (box of 100 pieces)
24T0385		O-ring for test cylinder (P/N 14T0100)
31T0010		Disposable copper foil strip for ASTM D7095 (one piece)
31T0011		Scouring pad 400 grit
14T0109		Test tube holder test jar conform ASTM D4048
31T0012		Test jar ASTM D4048
31T0013		Vented cork for test jar (P/N 31T0012). 10 pieces.

D130



Corrosiveness to copper from Petroleum Products

Accessories

Table 4: Suggested accessories

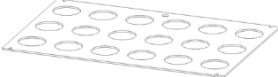

P/N	Description	ASTM D130, IP 154	Suggested quantity	IP 112, ASTM D4048	Suggested quantity	ASTM D7095	Suggested quantity
14T0100	Test vessel with o-ring	o	6			o	6
31T0003	Test standard	o	1	o	1	o	1
31T0002	Copper strip	o	20	o	20		
31T0001.100	Sanding paper P220	o	1				
09T0010	Test tube 25 x150mm	o	20			o	20
14T0102	Test tube holder	o	6			o	6
31T0005	Silicon carbide powder	o	1	o	1		
31T0000	Multistrip vise	o	1	o	1	o	1
09T0011	Flat glass viewing testtube	o	6	o	6	o	6
25T0928BW	Thermometer similar to ASTM 34C	o	1	o	1	o	1
08T0001	Bath fluid silicon oil 20-150°C 20ltr			o	1		
25T2154	Thermometer holder	o	1	o	1	o	1
31T0009.100	Sanding paper P240			o	1		
31T0008	Vented cork for test tube	o	1			o	1
24T0385	O-ring for test vessel (P/N 14T0100)	o	6			o	6
31T0011	Scouring pad 400 grit					o	1
31T0010	Disposable copper foil strip					o	20
14T0109	Test jar holder ASTM D4048			o	6		
31T0012	Test jar ASTM D4048			o	20		
31T0013	Vented cork for test for ASTM D4048			o	20		

Table 5: Alternative setup offering 18 positions (instead of 6)

P/N	Picture	Quantity	Description
00T0681		1	TC40 230V/50-60Hz
00T0851			TC40 115V/60Hz
03T2313		1	Cover with 18 * ø 51 mm openings
14T0101		18	Lid + mounting hook; number of pieces to be ordered separately, depending on number of test cylinder used

Corrosiveness to copper from Petroleum Products

Accessories

Table 6: Alternative setup offering 63 positions for glass test tubes			
P/N	Picture	Quantity	Description
00T0681		1	TC40 230V/50-60Hz
00T0851			TC40 115V/60Hz
03T2315		1	Cover and levelling platform with 63 * ø 27 mm openings for glass test tube (P/N 09T0010)



D130